



TITAN^{MD}

ACCESSORIES





THE BEST AND LONGEST WARRANTY IN THE INDUSTRY

Four-Year Manufacturer's Defect

We pledge that our sprayers are free from defects in materials and workmanship. This excludes normal wear items and consumables such as filters, piston, packings, tips, etc.

Lifetime DuraLife Brushless HE and PMDC Brushless Motor Warranty

If the motor fails for any reason (including wear) for as long as you own the sprayer, we will replace the motor at no cost to you.

Limited Lifetime DCX Motor Warranty

If the motor fails from normal usage for as long as you own the sprayer, we will replace the motor at no cost to you.

Gas Engine Warranty

3-year Honda® and 2-years all others.

Two-Year Turbine Warranty

Lifetime Drive Train Warranty

If the drive train fails from normal usage for as long as you own the sprayer, we will replace the drive train at no cost to you.

Lifetime Warranty on PermaStroke™ Technology Fluid Pump

Get a lifetime warranty on the PermaStroke Technology fluid pump. If the fluid pump fails for any reason (including wear) for as long as you own the sprayer, we will replace the fluid pump at no cost to you.

35-Day Satisfaction Guarantee

If for any reason the sprayer does not perform up to your expectations within 35 days, the sprayer can be exchanged for the identical model or full credit toward the purchase of a Titan sprayer of larger size and value.

Express Parts Program

- More than 550 Authorized Service Centers nationwide
- The most common repair parts are guaranteed to be in stock 100% of the time
- If for any reason your preferred Authorized Service Center is out of stock, free 2nd day air is available when ordered by 3:00 pm (ET)

SEE BACK PAGE FOR OUR PLATINUM AND ELITE PROGRAMS.



TITAN®

ACCESSORIES

04 AIRLESS GUNS

An industry leader in spray gun technology – Titan offers a full line of the best quality airless guns for every application imaginable.

07 AIRLESS TIPS

Titan offers a full range of spray tips for a full range of applications.

12 GUN ACCESSORIES

Titan has a guard for every tip and the best paint filters available. And if your arms just aren't long enough we have a reach tool or gun extension.

16 AIRLESS HOSES

Designed to withstand time and pressure, Titan's full line of airless hoses will have you covered for every job.

18 ROLLERS

Our rollers have the speed of a sprayer and the control of a roller.

19 LIQUIDS

Titan has all the products you need to keep your equipment/accessories clean and functioning in top condition.

20 FITTINGS

Need more hose length or need to alter the angle of the hose connected to the sprayer? You need Titan manifolds and fittings.

22 LINE STRIPING ACCESSORIES

Check out our hard-working assortment of accessories devoted specifically to pavement and turf marking.

24 HVLP GUNS & ACCESSORIES

For contractors and finishing professionals who expect flawless results, we have the tools for the perfect finish.

OUR MISSION

When your business depends on the tools you use,
you need to count on the people who make them.





Our relentless commitment to helping all professional painters be
their best leads to better work, improved ROI and growing business.

RED SERIES AIRLESS GUNS

INTRODUCING

RX-APEX

AIRLESS SPRAY GUN

-  **All-Day Trigger®**
28% lighter trigger pull force and 74% less hold force.
-  **FingerPrint+ Grip™**
Fully adjustable grip delivers maximum customization.
-  **Infinity Packing®**
2X the gun life by reversing the seat and changing the ball.
-  **Free-Flow Swivel**
Only direct feed airless gun with built-in swivel.

- ◆ Comes with two-finger trigger
- ◆ Pressure rated at 5000 PSI (34.5 MPa)

| DESCRIPTION | PART NO. |
|--|----------|
| RX-Apex, Non-Filtered Airless Gun with TR ¹ Tip | 0538070 |
| RX-Apex, Filtered Airless Gun with TR ¹ Tip | 0538075 |
| RX-Apex, Non-Filtered Airless Gun, Hose & TR ¹ Tip Kit | 0538072 |
| RX-Apex, Non-Filtered, High Pressure Airless Gun, Hose & TR ¹ Tip Kit | 0538073 |
| RX-Apex, Filtered Airless Gun, Hose & TR ¹ Tip Kit | 0538076 |
| RX-Apex, Filtered Airless Gun, Hose & TR ¹ HEA Tip Kit | 0538077 |



3 Grip Sizes Available

FingerPrint+ Grip



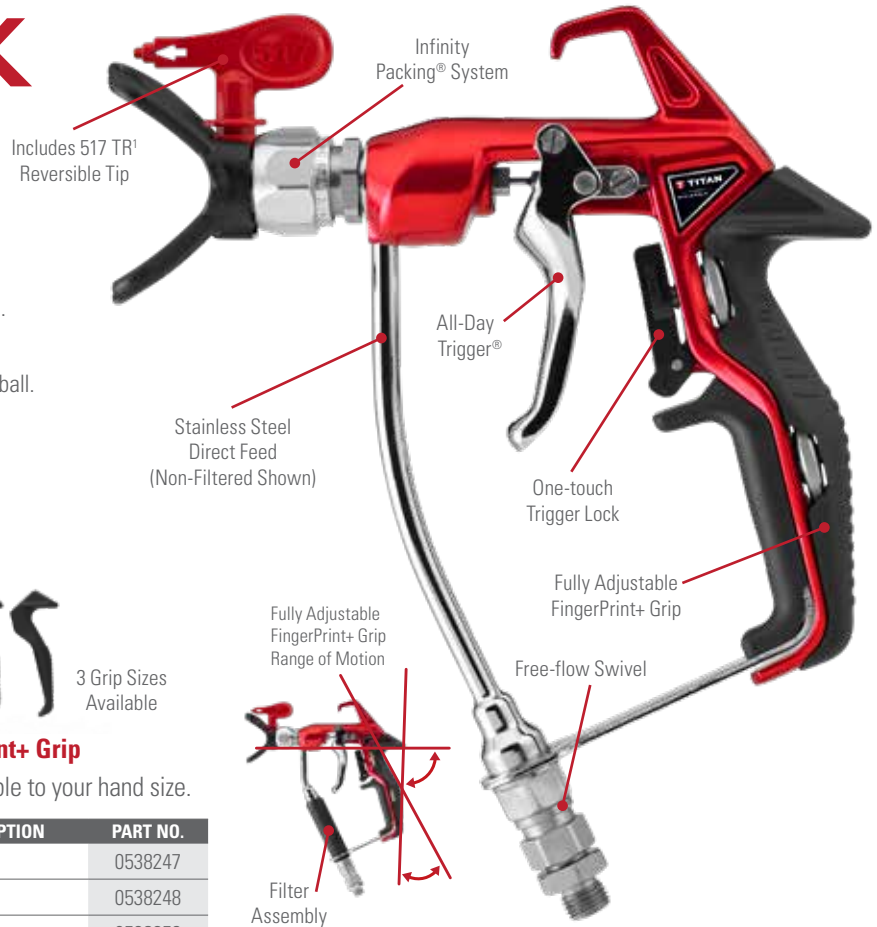

Customizable to your hand size.

| DESCRIPTION | PART NO. |
|-------------|----------|
| Small | 0538247 |
| Medium | 0538248 |
| Full | 0538256 |



RX-PRO®

AIRLESS SPRAY GUN

-  **Ultra-light Trigger**
30% lighter than the competitors trigger pull decreasing fatigue.
-  **FingerPrint Grip®**
Customize the grip to comfortably fit any painter's hand.
-  **Infinity Packing®**
2X the gun life by reversing the seat and changing the ball.
-  **Onboard Tools**
Smart tools that make jobsite life easier.

- ◆ Comes with both two and four-finger trigger
- ◆ Pressure rated at 3600 PSI (24.8 MPa)

| DESCRIPTION | PART NO. |
|---|----------|
| RX-Pro Airless Gun with TR ¹ Tip | 0538020 |
| RX-Pro Gun, Hose, Whip & Tip Kit | 0538022 |
| RX-Pro Gun, Hose & Tip Kit (8-pk) | 0538022A |
| RX-Pro Gun, Hose, Whip & HEA™ Tip Kit | 0538033 |
| RX-Pro Ball Valve | 0538221 |
| RX-Pro Seat | 594-033 |
| RX-Pro Packing Seal Assy. | 0538204A |



3 Grip Sizes Available

FingerPrint Grip



Customizable to your hand size.

| DESCRIPTION | PART NO. |
|-------------|----------|
| Small | 0538217 |
| Medium | 0538218 |
| Large | 0538219 |



RX-80™

AIRLESS SPRAY GUN

-  **Comfort Grip™**
Ergonomic design brings added comfort.
-  **Longer Life Packing Kit**
Lasts longer with improved performance.
-  **Onboard Tools**
Smart tools that make jobsite life easier.

- Comes with two or four-finger trigger
- Pressure rated at 3600 PSI (24.8 MPa)

| DESCRIPTION | PART NO. |
|---|----------|
| RX-80 Airless Gun, Four-Finger with TR ¹ | 0538005 |
| RX-80 Airless Gun, Two-Finger with TR ¹ | 0538006 |
| RX-80 Airless Gun, Four-Finger with SC-6+ | 0538007 |
| RX-80 Airless Gun, Two-Finger with SC-6+ | 0538008 |
| RX-80 4-Finger Gun, Hose and Tip Kit with TR ¹ * | 0538010 |
| RX-80 4-Finger Gun, Hose and Tip w/ SC-6+* | 0538011 |
| RX-80 Repair Kit | 0538215 |

*Includes additional 3' whip hose and a 2-finger trigger.

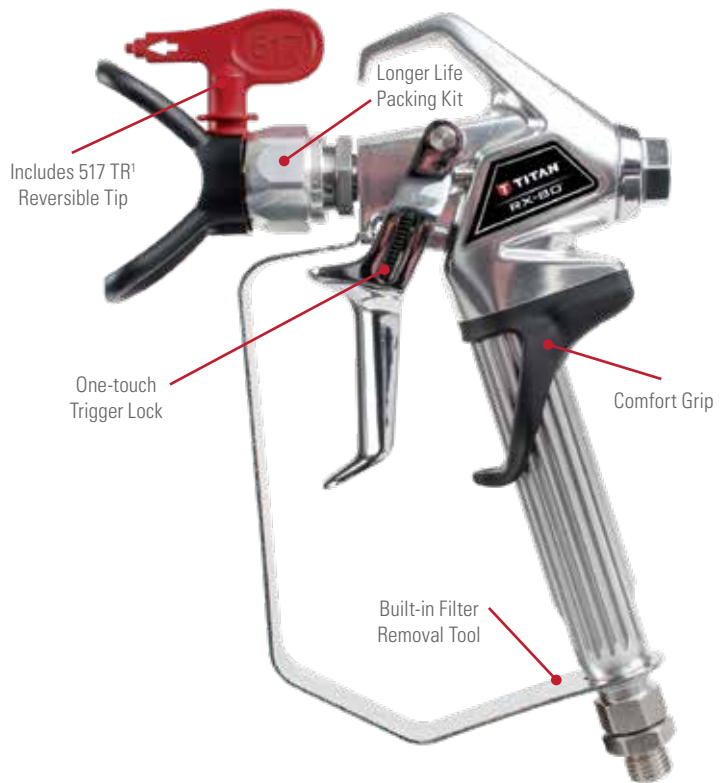

S-Series: Spray Specialized Coatings with Ease

S-3 Airless Gun

- In-handle filter
- Easy four-finger trigger pull
- 1/4" swivel reduces hose kinks
- Pressure rated at 3900 PSI (26.9 MPa)



| DESCRIPTION | PART NO. |
|----------------------------------|----------|
| S-3 Gun with TR ¹ Tip | 0550060 |
| S-3 Gun, Hose and Tip Kit | 0550065 |
| S-3 Repair Kit | 550-275 |

S-7 Airless Gun

- In-handle filter
- Available in two swivel sizes
- Easy four-finger trigger pull
- Swivel reduces hose kinks
- Includes 517 TR¹ high pressure, heavy-duty reversible tip and guard
- Pressure rated at 7700 PSI (53.1 MPa)



| DESCRIPTION | PART NO. |
|--------------------------|----------|
| S-7 Gun with 1/4" Swivel | 550-260 |
| S-7 Gun with 3/8" Swivel | 550-270 |
| S-7 Repair Kit | 550-276 |

Entry Level Contractor Airless Guns

LX-40 Airless Gun 550-540

- All metal construction
- In-handle filter
- Tungsten carbide ball valve ensures long life
- Includes 517 TR¹ reversible tip
- Pressure rated at 3000 PSI (20.7 MPa)



LX-50 Airless Gun 0286021

- All metal construction
- In-handle filter
- Tungsten carbide ball valve ensures long life
- Includes 517 TR¹ reversible tip
- Pressure rated at 3000 PSI (20.7 MPa)



FROM FINE FINISHING TO THE HARSHTEST COATINGS

From the harshest coatings (Mastic Guns) to detailed fine finish work (GM 3600) Titan has a gun that fits your needs.



GM 3600 Gun

M-4 Mastic Gun

GM 3600 Gun

This air-assisted airless gun works with both standard reversible tips and Brilliant™ Flat Tips. It offers ergonomic comfort and a reversible tip system without sacrificing finish quality.

- ◆ Inline filter for clean coatings
- ◆ Stainless steel fluid passages
- ◆ Pressure rated at 3600 PSI (24.8 MPa)

| DESCRIPTION | PART NO. |
|--|----------|
| 3600 AirCoat Gun with Reversible Tip Guard | 0524357 |
| Air Cap Assembly for Reversible Tip | 0524359 |
| 3600 AirCoat Gun with Flat Tip Guard* | 0524358 |
| Air Cap Assembly for Flat Tip | 0524360 |
| AirCoat Test Air Cap Kit | 0524229 |

*Includes 9/20 Flat Tip.

| BRILLIANT™ FLAT TIP SIZES (For GM 3600 Gun) | | | | |
|---|------------------|-------|--------------------|----------|
| DESIGNATION | ORIFICE DIAMETER | ANGLE | RECOMMENDED FILTER | PART NO. |
| 9/20 | 0.009 | 20 | 180 Mesh | 0526209 |
| 9/40 | 0.009 | 40 | 180 Mesh | 0526409 |
| 11/10 | 0.011 | 10 | 180 or 100 Mesh | 0526111 |
| 11/20 | 0.011 | 20 | 180 or 100 Mesh | 0526211 |
| 11/40 | 0.011 | 40 | 180 or 100 Mesh | 0526411 |
| 13/10 | 0.013 | 10 | 100 Mesh | 0526113 |
| 13/20 | 0.013 | 20 | 100 Mesh | 0526213 |
| 13/40 | 0.013 | 40 | 100 Mesh | 0526413 |
| 15/10 | 0.015 | 10 | 100 Mesh | 0526115 |
| 15/20 | 0.015 | 20 | 100 or 50 Mesh | 0526215 |
| 15/40 | 0.015 | 40 | 100 or 50 Mesh | 0526415 |
| 17/20 | 0.017 | 20 | 50 Mesh | 0526217 |
| 17/40 | 0.017 | 40 | 50 Mesh | 0526417 |

M-4 and M-8 Mastic Guns

- ◆ Straight line fluid passage allows max flow rate
- ◆ Angled handle for increased comfort
- ◆ Adjustable needle packing prolongs the life of critical wear parts
- ◆ Swivel allows freedom of movement without hose kinking
- ◆ Lightweight metal construction

| DESCRIPTION | PSI | PART NO. |
|----------------------|-----------------|----------|
| M-4 Mastic Gun | 3600 (24.8 MPa) | 0289013 |
| M-8 Mastic Gun | 7700 (53.1 MPa) | 0289014 |
| M-4 / M-8 Repair Kit | --- | 2347489 |

For Textured Applications

Splatter Nozzle 765-360

Add the splatter nozzle to any airless spray gun for smooth texture applications including orange peel and knock down. For best results use with S or M Series Airless Guns.

Air requirement 4-12 CFM at full open.



GM5000 Electrostatic Gun 0521133

Up to 20% higher transfer efficiency than competitive electrostatic sprayers.

- ◆ High-voltage ON/OFF at the gun
- ◆ Automatic error indication
- ◆ Easy to adjust atomization and pattern shape



THE INDUSTRY LEADER IN TIP TECHNOLOGY

Airless spray tips are a key component to the successful operation of an airless spray system. They define the spray pattern, control the flow, atomize the coating and ultimately tell the pump how hard it must work. A proper understanding of airless tips is critical to the success of any airless application.



Tip Characteristics

It is important to remember that the orifice size, in conjunction with the fan-width, determines the spray characteristics of the tip.

Tip Wear

When beginning a project, choosing the right tip size and fan width will determine both coating consumption and production time. If the tip size is wrong — either by choice or through wear — mil thicknesses will be too heavy and the finish will be unprofessional.

The spray pattern chart demonstrates what happens as a tip wears. As wear occurs, the pattern size decreases and the orifice size increases. You will have to make more passes to cover the same area. There is no standard rate of tip wear due to the variation of the abrasiveness of all coatings.

Examples for Understanding Airless Tips

Example A:

The larger the orifice with the same fan width, the greater the volume of paint applied to the area.

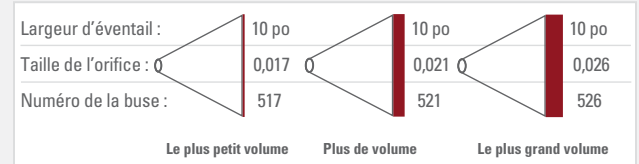

Example B:

The larger the fan width with the same orifice means the same amount of material is being applied over a greater area. The result is less volume of paint per square inch.

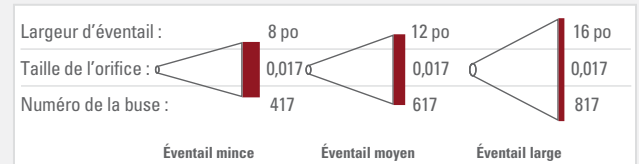

How a Tip Fan Pattern Typically Wears

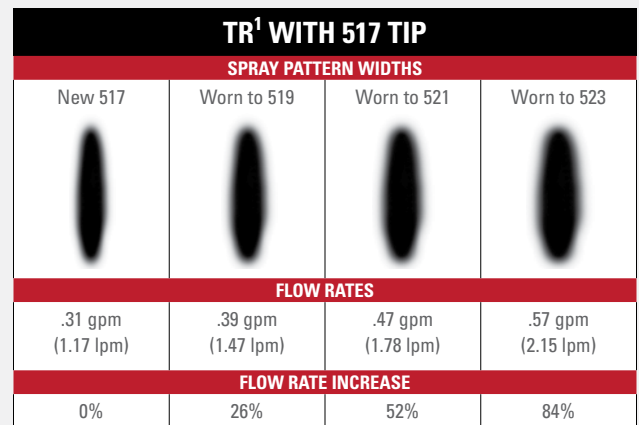
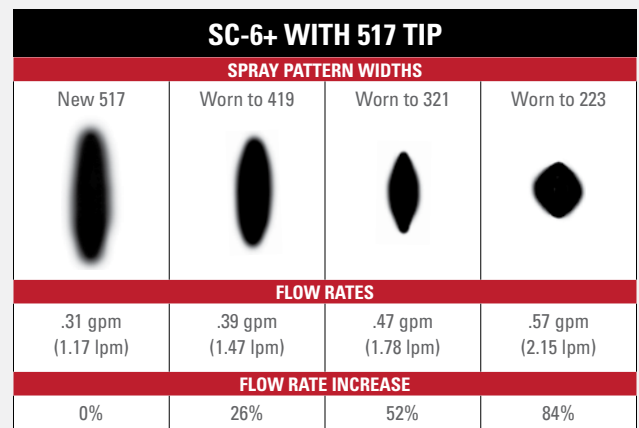

PREMIUM TR¹ REVERSIBLE TIP

- ▶ The best overall performing tip in the industry
- ▶ Fan pattern stays wider longer
- ▶ An orifice that outlasts competitive tips delivering consistent film thickness and less wasted paint
- ▶ Fits all Titan and most other industry spray gun guards

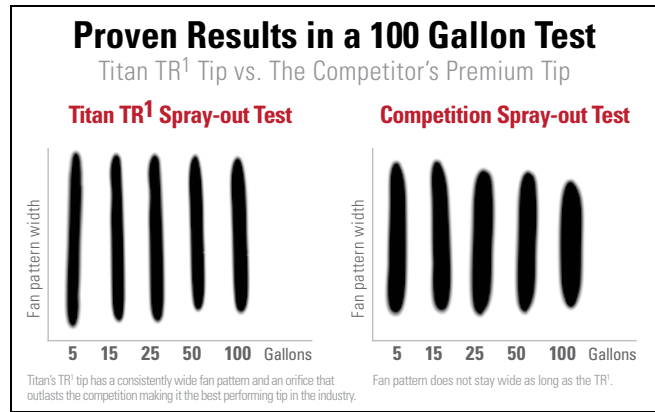

TR¹ Tips 695-XXX

| | | ORIFICE SIZE (INCHES) | | | | | | | | | | |
|-------------------|------------|-----------------------|-------|-------|-------|-------|-------|-------|-------|-------|------|--|
| | | 0.009 | 0.011 | 0.013 | 0.015 | 0.017 | 0.019 | 0.021 | 0.025 | 0.027 | | |
| FAN PATTERN WIDTH | INCHES | MM | | | | | | | | | | |
| | 2-4 | 51-102 | | | | | | | | | | |
| | 4-6 | 102-152 | 209 | 211 | 213 | 215 | 217 | | | | | |
| | 6-8 | 152-203 | | 311 | 313 | 315 | 317 | | | | | |
| | 8-10 | 203-254 | | 411 | 413 | 415 | 417 | | | | | |
| | 10-12 | 254-305 | | | 513 | 515 | 517 | 519 | 521 | 525 | | |
| | 12-14 | 305-356 | | | | | | | | | 627 | |
| | Flow (GPM) | --- | 0.09 | 0.12 | 0.18 | 0.24 | 0.31 | 0.39 | 0.47 | 0.67 | 0.78 | |
| | Flow (LPM) | --- | 0.34 | 0.45 | 0.68 | 0.91 | 1.17 | 1.47 | 1.78 | 2.53 | 2.95 | |

Maximum Working Pressure: 5000 PSI (34.5 MPa)



TR¹ High Pressure Tips 696-XXX

| | | ORIFICE SIZE (INCHES) | | | | | | | | | | | | | | | | | | | | |
|-------------------|------------|-----------------------|-------|-------|-------|-------|-------|-------|-------|-------|-------|-------|-------|-------|-------|-------|-------|-------|-------|-------|-------|-------|
| | | 0.007 | 0.009 | 0.011 | 0.013 | 0.015 | 0.017 | 0.019 | 0.021 | 0.023 | 0.025 | 0.027 | 0.029 | 0.031 | 0.033 | 0.035 | 0.037 | 0.039 | 0.043 | 0.045 | 0.055 | |
| FAN PATTERN WIDTH | INCHES | MM | | | | | | | | | | | | | | | | | | | | |
| | 2-4 | 51-102 | 107 | 109 | 111 | 113 | 115 | 117 | 119 | | | | | | | | | | | | | |
| | 4-6 | 102-152 | | 209 | 211 | 213 | 215 | 217 | 219 | 221 | 223 | 225 | 227 | | | | | | | | | |
| | 6-8 | 152-203 | | 309 | 311 | 313 | 315 | 317 | 319 | 321 | 323 | 325 | 327 | 329 | 331 | 333 | 335 | 337 | 339 | | | |
| | 8-10 | 203-254 | | 409 | 411 | 413 | 415 | 417 | 419 | 421 | 423 | 425 | 427 | 429 | 431 | 433 | 435 | | 439 | 443 | 445 | 455 |
| | 10-12 | 254-305 | | 509 | 511 | 513 | 515 | 517 | 519 | 521 | 523 | 525 | 527 | 529 | 531 | 533 | 535 | 537 | 539 | 543 | 545 | 555 |
| | 12-14 | 305-356 | | 609 | 611 | 613 | 615 | 617 | | | | | 627 | | | | | | | | | 655 |
| | 14-16 | 356-406 | | | | | | 717 | 719 | 721 | 723 | 725 | 727 | | 731 | 733 | 735 | | | | | |
| | 16-18 | 406-457 | | | | | | 817 | 819 | 821 | | | | | | 835 | 837 | 839 | 843 | | | |
| | 18-20 | 457-508 | | | | | | | | | | 923 | 925 | 927 | | 931 | | 937 | | | | |
| | Flow (GPM) | --- | 0.05 | 0.09 | 0.13 | 0.18 | 0.24 | 0.31 | 0.39 | 0.47 | 0.57 | 0.67 | 0.78 | 0.91 | 1.03 | 1.17 | 1.32 | 1.40 | 1.64 | 1.99 | 2.18 | 3.26 |
| | Flow (LPM) | --- | 0.19 | 0.34 | 0.45 | 0.68 | 0.91 | 1.17 | 1.47 | 1.78 | 2.15 | 2.53 | 2.95 | 3.44 | 3.89 | 4.42 | 4.99 | 5.29 | 6.20 | 7.52 | 8.24 | 12.32 |

Maximum Working Pressure: 7700 PSI (53.1 MPa)

TR¹ Line Striping Tips 697-XXX

| | | ORIFICE SIZE (INCHES) | | | | | | | | | | | | | |
|-------------------|------------|-----------------------|-------|-------|-------|-------|-------|-------|-------|-------|-------|-------|-------|-------|------|
| | | 0.013 | 0.015 | 0.017 | 0.019 | 0.021 | 0.023 | 0.025 | 0.027 | 0.029 | 0.031 | 0.035 | 0.039 | 0.043 | |
| FAN PATTERN WIDTH | INCHES | MM | | | | | | | | | | | | | |
| | 2 | 51 | 213 | 215 | 217 | 219 | | | | | | | | | |
| | 4 | 102 | 413 | 415 | 417 | 419 | 421 | 423 | 425 | 427 | 429 | 431 | 435 | 439 | 443 |
| | 6 | 152 | | 615 | 617 | 619 | 621 | 623 | 625 | 627 | 629 | 631 | 635 | 639 | 643 |
| | 8-10 | 203-254 | | | | | 821 | 823 | 825 | 827 | 829 | 831 | 835 | 839 | 843 |
| | Flow (GPM) | --- | 0.18 | 0.24 | 0.31 | 0.39 | 0.47 | 0.57 | 0.67 | 0.78 | 0.91 | 1.03 | 1.32 | 1.64 | 1.99 |
| | Flow (LPM) | --- | 0.68 | 0.91 | 1.17 | 1.47 | 1.78 | 2.15 | 2.53 | 2.95 | 3.44 | 3.89 | 4.99 | 6.20 | 7.52 |

Maximum Working Pressure: 5000 PSI (34.5 MPa)



TR¹ HEA TIP



Perfect for interior and exterior residential and commercial wall spraying.



The Right Mix For Production 330-XXX

| | INCHES | MM | ORIFICE SIZE (INCHES) | | | | | |
|-------------------|------------|---------|-----------------------|-------|-------|-------|-------|-------|
| | | | 0.011 | 0.013 | 0.015 | 0.017 | 0.019 | 0.021 |
| FAN PATTERN WIDTH | 4-6 | 102-152 | 211 | 213 | | | | |
| | 6-8 | 152-203 | 311 | 313 | | | | |
| | 8-10 | 203-254 | 411 | 413 | 415 | 417 | | 421 |
| | 10-12 | 254-305 | | | 515 | 517 | 519 | 521 |
| | 12-14 | 305-356 | | | 615 | 617 | 619 | 621 |
| | Flow (GPM) | --- | 0.09 | 0.12 | 0.18 | 0.24 | 0.31 | 0.47 |
| Flow (LPM) | --- | 0.34 | 0.45 | 0.68 | 0.91 | 1.17 | 1.79 | |

Maximum Working Pressure: 5000 PSI (34.5 MPa)

HEA | HIGH EFFICIENCY AIRLESS™

Revolutionary Low Pressure Technology

- Optimized to spray all architectural paints and coatings at 1,000 psi at production speed
- Decreases overspray up to 55% allowing contractors to spray more
- Less pressure equals less stress extending pump life and extending time between repacks
- Two times the life of a standard reversible tip
- Patented design

HIGHLY EFFICIENT FAN PATTERN

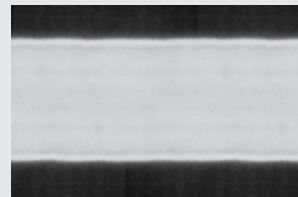

Latex paint through a standard 517 tip at 1,000 PSI



Latex paint through a HEA 517 tip at 1,000 PSI

- Feathered edge provides consistent coverage
- More forgiving pattern that decreases runs and drips
- Less kickback when triggered providing more control and less overspray
- Fits all industry standard guards

Maximize the Performance of your HEA Tip



HEA Gauge Assembly Kit 0580495

HIGH QUALITY SC-6+ REVERSIBLE TIP

- ▶ The industry's longest-lasting orifice
- ▶ Up to 22% wider fan pattern
- ▶ Fits all Titan and most industry standard guards



SC-6+ Tips 662-XXX

TITAN TIPS PAINT MORE

Titan Tips Vs. the Competition

Long-lasting orifice gives you more usable tip life, spraying a consistent film thickness and wasting less paint.

100 Gallons sprayed with a Titan SC-6+ tip*

100 Gallons sprayed with the competitor's standard tip*

*Assumes consistent application method

| | | ORIFICE WIDTH (INCHES) | | | | | | | | | | | | | | | | | | | | |
|-------------------|------------|------------------------|-------|-------|-------|-------|-------|-------|-------|-------|-------|-------|-------|-------|-------|-------|-------|-------|-------|-------|-------|-------|
| | | 0.007 | 0.009 | 0.011 | 0.013 | 0.015 | 0.017 | 0.019 | 0.021 | 0.023 | 0.025 | 0.027 | 0.029 | 0.031 | 0.033 | 0.035 | 0.039 | 0.043 | 0.045 | 0.051 | 0.055 | |
| FAN PATTERN WIDTH | INCHES | MM | 107 | 109 | 111 | 113 | 115 | 117 | | | | | | | | | | | | | | |
| | 2-4 | 51-102 | 207 | 209 | 211 | 213 | 215 | 217 | 219 | 221 | 223 | 225 | 227 | 229 | 231 | 233 | 235 | | | | | |
| | 4-6 | 102-152 | 307 | 309 | 311 | 313 | 315 | 317 | 319 | 321 | 323 | 325 | 327 | 329 | 331 | 333 | 335 | | | | | |
| | 6-8 | 152-203 | 407 | 409 | 411 | 413 | 415 | 417 | 419 | 421 | 423 | 425 | 427 | 429 | 431 | 433 | 435 | 439 | 443 | 445 | 451 | 455 |
| | 8-10 | 203-254 | | 509 | 511 | 513 | 515 | 517 | 519 | 521 | 523 | 525 | 527 | 529 | 531 | 533 | 535 | 539 | 543 | 545 | 551 | 555 |
| | 10-12 | 254-305 | | 609 | 611 | 613 | 615 | 617 | 619 | 621 | 623 | 625 | 627 | 629 | 631 | 633 | 635 | 639 | 643 | 645 | 651 | 655 |
| | 12-14 | 305-356 | | | | | | | 719 | 721 | | | | | | | 731 | | 735 | | | |
| 14-16 | 356-406 | | | | | | | | 719 | 721 | | | | | | | | | | | | |
| 16-18 | 406-457 | | | | | | | | | 821 | | | | | | | | | | | | |
| | Flow (GPM) | --- | 0.05 | 0.09 | 0.13 | 0.18 | 0.24 | 0.31 | 0.39 | 0.47 | 0.57 | 0.67 | 0.78 | 0.91 | 1.03 | 1.17 | 1.32 | 1.64 | 1.99 | 2.18 | 2.80 | 3.26 |
| | Flow (LPM) | --- | 0.19 | 0.34 | 0.45 | 0.68 | 0.91 | 1.17 | 1.47 | 1.78 | 2.15 | 2.53 | 2.95 | 3.44 | 3.89 | 4.42 | 4.99 | 6.20 | 7.52 | 8.24 | 10.58 | 12.32 |

Maximum Working Pressure: 5000 PSI (34.5 MPa)

SC-6+ Widespray Tips 661-XXX

| | | ORIFICE SIZE (INCHES) | | | | | | | | | | |
|-------------------|------------|-----------------------|-------|-------|-------|-------|-------|-------|-------|-------|-------|------|
| | | 0.019 | 0.021 | 0.023 | 0.025 | 0.027 | 0.029 | 0.031 | 0.033 | 0.035 | 0.037 | |
| FAN PATTERN WIDTH | INCHES | MM | 1219 | 1221 | 1223 | 1225 | 1227 | 1229 | 1231 | 1233 | 1235 | 1237 |
| | 24-26 | 610-660 | 0.39 | 0.47 | 0.57 | 0.67 | 0.78 | 0.91 | 1.03 | 1.17 | 1.32 | 1.47 |
| | Flow (GPM) | --- | 1.47 | 1.78 | 2.15 | 2.53 | 2.95 | 3.44 | 3.89 | 4.42 | 4.99 | 5.56 |
| | Flow (LPM) | --- | | | | | | | | | | |

Maximum Working Pressure: 5000 PSI (34.5 MPa)

SC-6+ Synergy Fine Finishing Tips

671-XXX

| | | ORIFICE SIZE (INCHES) | | | | |
|-------------------|------------|-----------------------|-------|-------|-------|------|
| | | 0.008 | 0.010 | 0.012 | 0.014 | |
| FAN PATTERN WIDTH | INCHES | MM | 208 | 210 | 212 | 214 |
| | 4-6 | 102-152 | 308 | 310 | 312 | 314 |
| | 6-8 | 152-203 | 408 | 410 | 412 | 414 |
| | 8-10 | 203-254 | | 510 | 512 | |
| | 10-12 | 254-305 | | | | 612 |
| | 12-14 | 305-356 | | | | |
| | Flow (GPM) | --- | 0.07 | 0.11 | 0.16 | 0.21 |
| | Flow (LPM) | --- | 0.26 | 0.42 | 0.60 | 0.79 |

Maximum Working Pressure: 5000 PSI (34.5 MPa)

VERSATILE TR² REVERSIBLE TIP

- ▶ One tip with two fan patterns – it's speed and control at your fingertips.
- ▶ Switch to wide or narrow fan pattern with a twist
- ▶ Consistent film thickness when using wide or narrow fan pattern

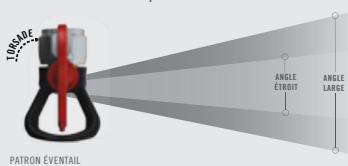

TR² Tips 692-XXX

| | | ORIFICE SIZE (INCHES) | | | | | | | | |
|-------------------|------------|-----------------------|-------|-------|-------|-------|-------|-------|-------|------|
| | | 0.011 | 0.013 | 0.019 | 0.021 | 0.023 | 0.027 | 0.031 | 0.035 | |
| FAN PATTERN WIDTH | INCHES | MM | 311 | 313 | | | | | | |
| | 6-8 | 152-203 | | | | | | | | |
| | 8-10 | 203-254 | | | | | | | | |
| | 10-12 | 254-305 | | | 519 | 521 | | | 535 | |
| | 12-14 | 305-356 | | | | | | 627 | 635 | |
| | 16-18 | 406-457 | | | | | | | 831 | |
| | 24-26 | 610-660 | | | | | 1223 | | 1231 | |
| | Flow (GPM) | --- | 0.13 | 0.18 | 0.39 | 0.47 | 0.57 | 0.78 | 1.03 | 1.32 |
| | Flow (LPM) | --- | 0.45 | 0.68 | 1.47 | 1.78 | 2.15 | 2.95 | 3.89 | 4.99 |

Maximum Working Pressure: 5000 PSI (34.5 MPa)



A FULL SPECTRUM OF SPRAY TIPS FOR A FULL RANGE OF APPLICATIONS

Flat Tips 002-XXX

- Precision machined from the highest quality Tungsten Carbide
- Solvent-proof seal holds up against the harshest coatings
- Pressure rated to 5000 PSI (34.5 MPa)



| | | ORIFICE SIZE (INCHES) | | | | | | | | | | | |
|-------------------|------------|-----------------------|------|------|------|------|------|------|------|------|------|------|------|
| | | INCHES | MM | .007 | .009 | .011 | .013 | .015 | .017 | .018 | .019 | .021 | .023 |
| FAN PATTERN WIDTH | 2-4 | 51-102 | 107 | 109 | 111 | | 115 | 117 | | 119 | 121 | 223 | |
| | 4-6 | 102-152 | 207 | 209 | 211 | 213 | 215 | 217 | | 219 | 221 | 225 | |
| | 6-8 | 152-203 | | 309 | 311 | 313 | 315 | 317 | 318 | 319 | 321 | 323 | |
| | 8-10 | 203-254 | 407 | 409 | 411 | 413 | 415 | 417 | 418 | 419 | 421 | 423 | |
| | 10-12 | 254-305 | 507 | 509 | 511 | 513 | 515 | 517 | 518 | 519 | 521 | 523 | |
| | 12-14 | 305-356 | 607 | | 611 | 613 | 615 | 617 | 618 | 619 | 621 | 623 | |
| | 14-16 | 356-406 | | | | 713 | 715 | 717 | | 719 | 721 | 723 | |
| | 16-18 | 406-457 | | | | 811 | 813 | 815 | 817 | 818 | 819 | 821 | 823 |
| | 18-20 | 457-508 | | | | 913 | 915 | | 918 | | | 923 | |
| | 20-22 | 508-559 | | | | | | | 1017 | | | 1021 | |
| | 22-24 | 559-610 | | | | | | | | | | | |
| | 24-26 | 610-660 | | | | 1213 | 1215 | | | 1218 | | 1221 | 1223 |
| | 26-28 | 660-711 | | | | | | | | | | | |
| | Flow (GPM) | | --- | 0.05 | 0.09 | 0.13 | 0.18 | 0.24 | 0.31 | 0.35 | 0.39 | 0.47 | 0.57 |
| Flow (LPM) | | --- | 0.19 | 0.34 | 0.49 | 0.68 | 0.91 | 1.17 | 1.32 | 1.47 | 1.78 | 2.15 | |

| | | ORIFICE SIZE (INCHES) | | | | | | | | | | | | | | | | | | | | | | |
|-------------------|------------|-----------------------|------|------|------|------|------|------|------|------|------|------|------|------|------|------|-------|-------|-------|-------|-------|------|-----|--|
| | | INCHES | MM | .025 | .026 | .027 | .029 | .031 | .033 | .035 | .036 | .039 | .041 | .042 | .043 | .047 | .049 | .052 | .055 | .058 | .062 | .072 | | |
| FAN PATTERN WIDTH | 2-4 | 51-102 | | | | | | 231 | | | | | | | | | | | | | | | | |
| | 4-6 | 102-152 | 225 | | | | | 231 | | | | | | | | | | | | | | | | |
| | 6-8 | 152-203 | 325 | | 327 | | | 331 | | | 336 | | | 342 | | | | 352 | | | | | | |
| | 8-10 | 203-254 | 425 | 426 | 427 | 429 | 431 | 433 | 435 | 436 | 439 | 441 | | 443 | | 449 | 452 | | | | | | 472 | |
| | 10-12 | 254-305 | 525 | | 527 | 529 | 531 | | 535 | 536 | 539 | | | 543 | | 549 | 552 | | | 558 | 562 | | | |
| | 12-14 | 305-356 | 625 | 626 | 627 | | 631 | 633 | 635 | 636 | | | 641 | | 643 | | 652 | 655 | | | | | | |
| | 14-16 | 356-406 | 725 | | 727 | | 731 | | 735 | | | | | | | | | | | | | | | |
| | 16-18 | 406-457 | 825 | | 827 | | 831 | | 835 | 836 | 839 | | | 843 | 847 | | | | | | | | 862 | |
| | 18-20 | 457-508 | 925 | 926 | | | 931 | | 936 | | | | | | | | | | | | | | 962 | |
| | 20-22 | 508-559 | | | | | 1031 | | | | | | | | | | | | | | | | | |
| | 22-24 | 559-610 | | | | | | | | | 1136 | | | | 1143 | | | | | | | | | |
| | 24-26 | 610-660 | | 1226 | | 1229 | 1231 | | | | | | | | | | | | | | | | | |
| | 26-28 | 660-711 | | | | | | | | | 1336 | | | | | | | | | | | | | |
| | Flow (GPM) | | --- | 0.67 | 0.73 | 0.78 | 0.91 | 1.03 | 1.17 | 1.32 | 1.40 | 1.64 | 1.81 | 1.90 | 1.99 | 2.38 | 2.58 | 2.91 | 3.26 | 3.62 | 4.14 | 5.58 | | |
| Flow (LPM) | | --- | 2.53 | 2.76 | 2.95 | 3.44 | 3.89 | 4.42 | 4.99 | 5.29 | 6.20 | 6.84 | 7.18 | 7.52 | 9.00 | 9.75 | 11.00 | 12.32 | 13.68 | 15.65 | 21.09 | | | |

Adjustable Self-Cleaning Tips 341-XXX

- Fully adjustable fan widths from 2" to 24" reduce overspray
- Perfect when changing from spraying walls to cutting in for trim work or around windows
- Self-cleaning feature eliminates costly downtime

| ORIFICE RANGE | COATING RANGE | PART NO. |
|---------------|---------------------|----------|
| .005-.018 | Lacquer and Stain | 341-015 |
| .007-.019 | Lacquer and Stain | 341-020 |
| .007-.026 | Lacquer and Enamels | 341-024 |
| .011-.026 | Lacquer and Enamels | 341-028 |
| .017-.035 | High Builds | 341-041 |
| .021-.054 | Very Heavy | 341-049 |



Adjustable Self-Cleaning Tip



Metering Orifice

Metering Orifice 512-XXX

Designed to produce a more complete atomization of the spray pattern. Increases your transfer efficiency by allowing you to spray at lower pressures.

When ordering, always use a metering orifice that is at least .004 larger than the spray tip being used. Example: a .019 tip should be used with a .023 Metering Orifice.

| ORIFICE - INCHES | MAX. RECOMMENDED TIP SIZE | PART NO. |
|------------------|---------------------------|----------|
| .011 | .007 | 512-011 |
| .013 | .009 | 512-013 |
| .015 | .011 | 512-015 |
| .018 | .013 | 512-018 |
| .021 | .017 | 512-021 |
| .023 | .019 | 512-023 |
| .026 | .021 | 512-026 |
| .031 | .026 | 512-031 |
| .035 | .031 | 512-035 |
| .039 | .035 | 512-039 |

A GUARD FOR EVERY TIP

Titan tip guards are designed to maximize airflow with minimal overspray. With a guard for every tip and the universal fitting which matches most industry standard guns we have you covered.



No Build Guard (7/8") 0289228

Aerodynamic dimple design allows for better airflow and less paint build up. Seal cavity on safety guard has large "flats" for quick and easy installation of seal.

- ◆ Rotate guard without loosening from gun
- ◆ No tools needed for installation
- ◆ Interchangeable with most industry spray guns
- ◆ Pressure rated at 5000 PSI (34.5 MPa)

High Pressure Tip Guard (7/8") 661-027

- ◆ Interchangeable with most industry spray guns
- ◆ Pressure rated at 7700 PSI (53 MPa)

Adjustable and Flat Tip Guard

- ◆ Interchangeable with most industry spray guns
- ◆ Pressure rated at 5000 PSI (34.5 MPa)



| DESCRIPTION | PART NO. |
|------------------------------|----------|
| 7/8" - 14 | 450-100A |
| 11/16" - 14 (Flat tips only) | 0153003 |



Seals

| DESCRIPTION | PART NO. |
|--|----------|
| Metal Retainer | 651-040 |
| Black Seal, Latex | 651-042 |
| White Seal, Solvent Resistant | 651-020 |
| White Seal, Solvent Resistant (6-pack) | 661-021 |
| Seal and Retainer Kit, Solvent Resistant (5-pack) | 661-020 |
| Seal and Retainer Kit, Solvent Resistant (12-pack) | 651-060 |
| Gasket Kit, 1/8" (12-pack) | 711-612A |
| Gasket Kit, 1/16" (12-pack) | 711-606 |

THE BEST FILTERS AVAILABLE

Nothing destroys a piston or a gun tip faster than debris in the coating. That's why you need the best paint filters available. Titan gun filters and manifold filters are designed for long life and maximum protection. They are made from stainless steel for strength and service. We offer a wide variety of mesh sizes from 0 to 150.

Gun and Pump Filters

Unthreaded filter design for quick and easy replacement.

For use with RX-Pro™, RX-80™, G-10, LX-30, LX-40, LX-50, LX-70, S-3 and S-7.

| UNTHREADED | | |
|------------------|---------------|-----------------|
| FILTERS | BULK PART NO. | 2-PACK PART NO. |
| Coarse (Green)* | 581-059 | 0089957 |
| Medium (White) | 581-060 | 0089958 |
| Fine (Yellow) | 581-062 | 0089959 |
| Extra Fine (Red) | 581-061 | 0089960 |

*Manifold filter for Advantage 400.



For use with LX-80^{II} and LX-80 Platinum.

| THREADED | | |
|------------------|---------------|-----------------|
| FILTERS | BULK PART NO. | 2-PACK PART NO. |
| Coarse (Green)* | 540-030 | 500-200-03 |
| Medium (White) | 540-060 | 500-200-06 |
| Fine (Yellow) | 540-100 | 500-200-10 |
| Extra Fine (Red) | 540-150 | 500-200-15 |

*Manifold filter for 440i and Impact 400.



 Pump Manifold Filters

Pump Manifold Filters

For use on Impact® 440–1140; 640ix–1140ix and Elite 3500.

| MESH | PART NO. |
|----------------|------------|
| Coarse-30 Mesh | 730-067-30 |
| Medium-60 Mesh | 730-067 |
| Fine-100 Mesh | 730-067-10 |

For use on PowrTwin™ 4900, 5500, 6900, 8900, 10000 and 12000 Plus. PowrBeast™ 4700/7700/9700

| MESH | PART NO. |
|-----------------|----------|
| Mastic-0 Mesh | 930-004 |
| Coarse-5 Mesh | 930-005 |
| Medium-50 Mesh* | 930-006 |
| Fine-100 Mesh | 930-007 |

*Standard with sprayer. Includes ball.



For use on Hydra™, PowrTwin 3500 and 4500.

| MESH | PART NO. |
|-----------------|----------|
| Coarse-5 Mesh | 920-001 |
| Medium-50 Mesh* | 920-004 |
| Fine-100 Mesh | 920-005 |

*Standard with sprayer, excludes ball. Ball check sold separately (920-103).

For use on all 10" PowrCoat™ models.

| MESH | PART NO. |
|----------------|----------|
| Medium-60 Mesh | 0533514 |

For use on Titan E15, E20, G40 and G55.

| MESH | PART NO. |
|----------------|----------|
| Coarse-30 Mesh | 761-042 |

Pump Manifold Filter Plugs



| MESH | PART NO. |
|----------------------------|----------|
| Impact 400 | 0532357 |
| Impact 440, 540, 640 | 0552934 |
| Impact 740-1140 and 1200SF | 0558668 |

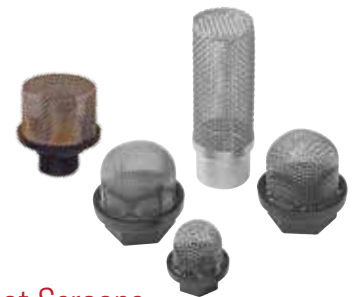

Inlet Screens

| SMALL | | |
|------------------|---------------|-------------------|
| MESH | BULK PART NO. | PACKAGED PART NO. |
| 30 mesh (Fine) | 700-900 | 700-900A |
| 10 mesh (Coarse) | 700-805 | 700-805A |
| 30 mesh (Male) | ---- | 0552947* |

*For PowrLiner 550 and 850 only

| LARGE | | |
|------------------|---------------|-------------------|
| MESH | BULK PART NO. | PACKAGED PART NO. |
| 30 mesh (Fine) | 710-191 | 710-191A |
| 10 mesh (Coarse) | 710-046 | 710-046A |

| HYDRAULIC AND PNEUMATIC | |
|---|----------|
| DESCRIPTION | PART NO. |
| PowrTwin 4900, 6900, 8900, 12000 Plus and XLT | 0509762A |
| All GHD | 710-046A |
| Hydra Pro IV | 0509762A |
| PowrCoat 10" (30 Mesh) | 0533968 |

In-Line Filter 550-223

Designed for added filtration or when using a gun without a filter.



 In-line Gun Filter

WHEN YOUR ARMS JUST AREN'T LONG ENOUGH

- ◆ Maximize the speed and efficiency of your operation
- ◆ Minimize danger – eliminate reaching from ladders
- ◆ Get the job done safely and quickly the first time
- ◆ Paint easily from a safe distance, keeping yourself and clothing clean



SprayGuide™

May your lines be straighter and your profits greater! This unique free-wheeling disc glides smoothly over virtually every surface.

Cut-in around windows, doors, trim and more without time-consuming prep work.

- ◆ Eliminates time-consuming masking or cutting in with brush
- ◆ Attaches to a gun extension or an extension pole (sold separately) decreasing ladder work
- ◆ Best if used with a 411 tip. (Not included)
- ◆ Pressure rated at 3600 PSI (24.8 MPa)

| DESCRIPTION | PART NO. |
|--|----------|
| SprayGuide Complete Kit | 0538900 |
| SprayGuide Replacement Arm and Disk Only | 0538902 |



Aluminum Gun Extensions

Our aluminum gun extensions are lightweight and easy to handle and can be used with most brands of airless spray guns.

- ◆ Pressure rated at 3600 PSI (24.8 MPa)

7/8" x 14 Thread is Standard

| DESCRIPTION | PART NO. |
|-------------|----------|
| 6" (15 cm) | 651-070 |
| 12" (30 cm) | 651-071 |
| 18" (45 cm) | 651-072 |
| 24" (60 cm) | 651-073 |

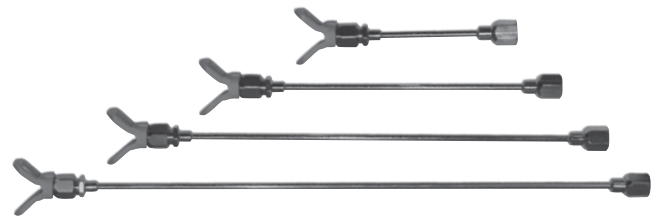

High Pressure, Alloy Steel Gun Extensions

When you need something a little more heavy duty. Can be used with most brands of airless spray guns.

- ◆ Pressure rated at 7700 PSI (53.1 MPa).

7/8" x 14 Thread is Standard

| DESCRIPTION | PART NO. |
|-------------|----------|
| 6" (15 cm) | 611-280 |
| 12" (30 cm) | 611-281 |
| 18" (45 cm) | 611-282 |
| 24" (60 cm) | 611-283 |

Non-Spit Valve 0521012

Eliminate the spitting that occurs when spraying with pole extensions. Universal connection works with most industry extensions and guns.

- ◆ Pressure rated at 3600 PSI (24.8 MPa)





Swivel Head 0538029

Titan's new easy turn swivel rotates 260 degrees for greater versatility and accessibility.

| DESCRIPTION | PART NO. |
|---------------------------------------|----------|
| 7/8" x 14 Thread Swivel Head - Female | 0538029 |
| 7/8" x 14 Thread Swivel Head - Male | 711-600 |



Extension Pole

These lightweight aluminum extensions are constructed with inner core ribs which reinforce the poles and greatly increase their rigidity. The inner core rib construction allows different length poles to be easily coupled together up to 12', while maintaining the proper rigidity to suit most job conditions.

- Reach high out-of-the-way places when spray or pressure rolling
- Adapts to most airless guns
- Includes Extension Pole Coupling (0509908)
- Pressure rated at 3600 PSI (24.8 MPa)

| DESCRIPTION | PART NO. |
|--|-----------|
| 1.5' (0.46 m) Pole | 310-381-1 |
| 3' (0.9 m) Pole | 310-383-1 |
| 6' (1.8 m) Pole | 310-386-1 |
| 3' Extension Pole with Swivel Head, 7/8" Nut | 310-390 |
| 6' Extension Pole with Swivel Head, 7/8" Nut | 0279976L |

LX-75 In-Line Gun 550-475

- All metal construction
- A natural extension to any pole
- In-handle filter
- Swivel reduces hose kinks and ensures effortless control
- Pressure rated at 3600 PSI (24.8 MPa)

Repair Kit (550-521)



6' Outrigger 757-920

Convert existing gun to 6' (2 m) pole gun and back in seconds. Outrigger allows you to increase production and profits. No additional hoses or fittings required.

- Constructed of lightweight and rigid aluminum to reduce arm fatigue
- Large gun installation holder and knob
- Adapts to all Titan airless spray guns and most manufacturers' airless spray guns



LX-75 Pole Gun 550-495

Reach those high, out-of-the-way places that normally require the use of a ladder or scaffolding.

- All metal construction
- Full-length needle ensures positive shut-off at tip
- Gun swivel
- In-handle filter
- Ergonomic design
- Pressure rated at 3600 PSI (24.8 MPa)

Repair Kit (550-487)

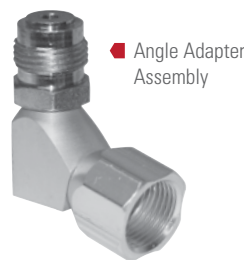

Angle Adapter Assembly 0509907

Adapt any extension pole to any standard airless gun. Because of its right-angle design, the angle adapter allows the pole to extend from the gun at the same angle as the handle. The result is greater efficiency and comfort.

- Pressure rated at 3600 PSI (24.8MPa)

Extension Pole Coupling 0509908

Allows you to connect different length extruded poles together to create different lengths for any application. (Do not exceed 12')

THE RIGHT EQUIPMENT FOR THE JOB



High Quality Airless Fluid Hoses and Whip Hoses

| I.D. | LENGTH | | MAX. WORKING PRESSURE - PSI (MPa) | | | | | END CONNECTION |
|-------|--------|--------|-----------------------------------|-------------|-------------|-------------|-------------|-----------------|
| | | | 3300 (22.8) | 3600 (24.8) | 4500 (31.0) | 6500 (44.8) | 7500 (51.7) | |
| | FEET | METERS | PART NO. | PART NO. | PART NO. | PART NO. | PART NO. | |
| 1/8" | 3 | 0.9 | --- | --- | 290685 | --- | --- | 1/4" NPSM (F/M) |
| | 3 | 0.9 | 291004 | --- | --- | --- | --- | 1/4" NPSM (F/M) |
| 3/16" | 5 | 1.5 | 316-506 | --- | --- | --- | --- | 1/4" NPSM (F/M) |
| | 9 | 2.7 | 550-222 | --- | --- | --- | --- | 1/4" NPSM (F/M) |
| | 25 | 7.6 | 291007 | --- | --- | --- | --- | 1/4" NPSM (FBE) |
| | 50 | 15.2 | 291008 | --- | --- | --- | --- | 1/4" NPSM (FBE) |
| 1/4" | 3 | 0.9 | --- | --- | 2389428 | 2389440 | 2389450 | 1/4" NPSM (FBE) |
| | 6 | 1.8 | 316-533* | --- | 2389430 | 2389442 | 2389452 | 1/4" NPSM (FBE) |
| | 6 | 1.8 | 550-227 | --- | --- | --- | --- | 1/4" NPSM (F/M) |
| | 25 | 7.6 | 316-513 | --- | --- | --- | --- | 1/4" NPSM (FBE) |
| | 50 | 15.2 | 316-505 | 286498 | 2389429 | 2389441 | 2389451 | 1/4" NPSM (FBE) |
| | 100 | 30.5 | --- | --- | 2389427 | 2389439 | 2389449 | 1/4" NPSM (FBE) |
| 3/8" | 6 | 1.8 | --- | --- | 2389436 | 2389446 | 2389456 | 3/8" NPSM (FBE) |
| | 25 | 7.6 | 508342 | --- | --- | --- | --- | 3/8" NPSM (FBE) |
| | 50 | 15.2 | 291006 | 286499 | 2389434 | 2389445 | 2389455 | 3/8" NPSM (FBE) |
| | 100 | 30.5 | --- | --- | 2389432 | 2389444 | 2389453 | 3/8" NPSM (FBE) |
| 1/2" | 25 | 7.6 | 225-112* | --- | --- | --- | --- | 1/2" NPSM (FBE) |
| | 50 | 15.2 | 250-112* | --- | 2389425 | 2389438 | 2389448 | 1/2" NPSM (FBE) |
| | 100 | 30.5 | --- | --- | 2389424 | 2389437 | 2389447 | 1/2" NPSM (FBE) |
| 3/4" | 50 | 15.2 | --- | --- | --- | 2389443 | --- | 3/4" NPSM (FBE) |

*Textile Braid. Spring guards at both ends.

FBE Female Both Ends, NPT National Pipe Tapered Thread, NPSM National Pipe Straight Mechanical Thread, MBE Male Both Ends, F/M 1 Female / 1 Male Connection

Moisture Resistant Hose

| DESCRIPTION | PART NO. |
|-----------------------|-------------|
| 3/8" x 7500 PSI x 50' | 375750050ML |
| 1/2" x 7500 PSI x 50' | 500750050ML |



Hose Shield 0521424

Protect your airless hose from paint and abrasion damage with a durable four-mil poly hose cover. Comes in 1100' lengths with perforations every 5' to fit any length of hose. Works with 1/4" and 3/8" hoses.



Hose sold separately.



Reel-EZ Hose Reels

Eliminate hose hassles while increasing your production. Both models mount to most major manufacturers' paint sprayers with similar designs.

- ▶ The 16" Cart-Mount holds up to 100' (30.5 m) of 1/4" airless hose
- ▶ The 10" Skid-Mount holds up to 50' (15.2 m) of 1/4" airless hose
- ▶ Pressure rated at 3600 PSI (25 MPa)

Fits handles/carts 3/4" to 1-1/2" in diameter.

| DESCRIPTION | PART NO. |
|----------------|----------|
| 16" Cart-Mount | 769-100 |
| 10" Skid-Mount | 769-200 |



High Pressure Swivels

- ▶ Decreases resistance while spraying reducing overall fatigue
- ▶ Reduces hose kinking
- ▶ Pressure rated at 5000 PSI (34.5 MPa)

| DESCRIPTION | PART NO. |
|--|----------|
| Gun-to-Hose / Hose-to-Pump 1/4" (0.63 cm) NPS (F) x 1/4" (0.63 cm) NPS (M) | 0509985 |
| Hose-to-Hose 1/4" (0.63 cm) NPS (M) x 1/4" (0.63 cm) NPS (M) | 0502135 |



Air Spray Hoses

| DESCRIPTION | PART NO. |
|--------------------------|----------|
| 25' x 3/8" Air (Red) | 0550893 |
| 30' x 3/8" Air (Red) | 0295689 |
| 50' x 3/8" Air (Red) | 0550891 |
| 25' x 1/4" Fluid (Black) | 0550894 |
| 30' x 3/8" Fluid (Black) | 0277348 |
| 50' x 3/8" Fluid (Black) | 0275281 |
| 4' Twin Hose | 0552302 |
| 25' Twin Hose | 0552303 |

Air-Assisted Airless Spray Hoses

| DESCRIPTION | PART NO. |
|---------------------|----------|
| 25' Bonded Hose | 9984595 |
| 50' Bonded Hose | 0524333 |
| 4' 6" Air Whip Hose | 0550860 |
| 5' Fluid Whip Hose | 0550861 |

High Pressure Fluid Gauge Kit 0508239

Includes: 5000 PSI (34.5 MPa) high pressure fluid gauge attached to a T-Fitting with one 1/4" (M)(.63cm) fitting & one 1/4" (F)(.63cm) fitting.

Fluid Gauge Only (0508626)



HEA Pressure Gauge 0580495

Maximize the performance of your TR¹ HEA Tips.



PRODUCTIVE BACKROLLING



SPRAYROLLER®

DO TWO JOBS AT ONCE

- Designed to spray and back roll in one motion
 - One person doing the work of two employees
 - Reduces overspray decreasing Prep work
 - Professional finish from a new/novice applicator
 - Provides consistent mil thickness on textured surfaces
 - Gives a roller finish; easier to touch-up
 - Modular design
 - Attaches to the Titan SprayGuide swivel
 - Uses any standard roller cover
 - Designed to be used with all airless sprayers and extension poles
- Quick tool-free changeover for the complete wall system

SPRAYGUIDE™ EXCLUSIVE CUT-IN TOOL

- No more taping, no more ladders
- Perfect for windows, doors and roof lines



SprayRoller Head with TR Tip

SprayRoller, SprayGuide & 3' Pole 2404013
SprayRoller & SprayGuide 2403959
SprayRoller (no tip) 2403780



INNER-FEED ROLLER®

ROLL NON-STOP UNTIL
THE JOB IS FINISHED

- Up to four times faster than standard rolling
- Never take the roller off the wall to go back to the tray; when the roller starts to get dry, simply pull the trigger to wet roller cover
- Never have to worry about dry edges
- More consistent mil thickness
- Designed to be used with all airless sprayers and any brand of extension pole
- Use the same swivel for both the SprayGuide and SprayRoller



Inner-feed
Roller Head

A FITTING FOR EVERY JOB

Spraying is more than just hooking up a hose. Sometimes the situation calls for extending hose length or altering the angle of the hose connected to the sprayer. That's when you need Titan manifolds and fittings. Our fittings are manufactured from quality carbon steel and plated for maximum corrosion resistance.

Couplings

HOSE TO HOSE

| DESCRIPTION | BULK PART NO. | PART NO. |
|---------------------------|---------------|----------|
| 1/4" NPT(M) x 1/4" NPT(M) | ---- | 05045 |
| 1/4" NPT(M) x 3/8" NPT(M) | 490-006 | 812-003 |
| 3/8" NPT(M) x 3/8" NPT(M) | 814-004 | 490-014 |
| 1/2" NPT(M) x 1/2" NPS(M) | ---- | 449-621 |

Maximum Working Pressure: 5000 PSI (34.5 MPa)



HIGH PRESSURE HOSE TO HOSE

| DESCRIPTION | PART NO. |
|------------------------------|----------|
| 1/4" NPTF (M) x 1/4" NPTF(M) | 9885642 |
| 3/8" NPTF (M) x 3/8" NPTF(M) | 9885643 |
| 1/2" NPTF (M) x 1/4" NPTF(M) | 9885644 |
| 3/4" NPTF (M) x 1/2" NPTF(M) | 9885645 |
| 3/8" NPTF (M) x 1/4" NPTF(M) | 9885646 |
| 1/2" NPTF (M) x 3/8" NPTF(M) | 9885647 |
| 1/2" NPTF (M) x 1/2" NPTF(M) | 9885648 |

Maximum Working Pressure: 7500 PSI (51.7 MPa)



MANIFOLD TO MANIFOLD

| DESCRIPTION | PART NO. |
|---------------------------|----------|
| 1/4" NPT(M) x 1/4" NPT(M) | 490-002 |
| 1/4" NPT(M) x 3/8" NPT(M) | 490-006 |
| 3/8" NPT(M) x 3/8" NPT(M) | 814-004 |
| 3/8" NPT(M) x 1/2" NPT(M) | 814-005 |
| 1/2" NPT(M) x 1/2" NPT(M) | 814-006 |
| 1/2" NPT(M) x 3/4" NPT(M) | 101-201 |
| 3/4" NPT(M) x 3/4" NPT(M) | 814-007 |

Maximum Working Pressure: 5000 PSI (34.5 MPa)



MANIFOLD TO HOSE

| DESCRIPTION | PART NO. |
|---------------------------|----------|
| 1/8" NPT(M) x 1/4" NPS(M) | 490-001 |
| 1/4" NPT(M) x 1/4" NPS(M) | 227-006 |
| 1/4" NPT(M) x 3/8" NPS(M) | 804-555 |
| 1/4" NPT(M) x 1/2" NPS(M) | 814-003 |
| 3/8" NPT(M) x 1/4" NPS(M) | 812-003 |
| 3/8" NPT(M) x 3/8" NPS(M) | 808-555 |
| 3/8" NPT(M) x 1/2" NPS(M) | 815-005 |
| 1/2" NPT(M) x 1/2" NPS(M) | 228-002 |
| 3/4" NPT(M) x 1/2" NPS(M) | 814-555 |

Maximum Working Pressure: 5000 PSI (34.5 MPa)



90° Street Elbows

| DESCRIPTION | PART NO. |
|---------------------------|----------|
| 3/8" NPT(F) x 3/8" NPT(M) | 818-002 |
| 1/2" NPT(F) x 1/2" NPT(M) | 818-003 |
| 3/4" NPT(F) x 3/4" NPT(M) | 818-010 |

Maximum Working Pressure: 5000 PSI (34.5 MPa)



Reducer Bushings

| DESCRIPTION | PART NO. |
|---------------------------|----------|
| 3/8" NPT(M) x 1/4" NPT(F) | 817-001 |
| 1/2" NPT(M) x 1/4" NPT(F) | 929-061 |
| 1/2" NPT(M) x 3/8" NPT(F) | 541-009 |
| 3/4" NPT(M) x 1/4" NPT(F) | 929-062 |
| 1" NPT(M) x 3/4" NPT(F) | 929-076 |
| 1-1/4" NPT(M) x 1" NPT(F) | 929-077 |

Maximum Working Pressure: 5000 PSI (34.5 MPa)



Pipe Tees

| DESCRIPTION | PART NO. |
|-------------|----------|
| 1/4" NPT(F) | 970-023 |
| 3/8" NPT(F) | 817-002 |
| 1/2" NPT(F) | 817-003 |
| 3/4" NPT(F) | 817-004 |

Maximum Working Pressure: 5000 PSI (34.5 MPa)

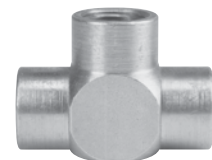

Swivel Unions

| DESCRIPTION | PART NO. |
|---------------------------|----------|
| 1/4" NPS(F) x 1/4" NPT(M) | 490-005 |
| 3/8" NPS(F) x 1/4" NPT(M) | 490-042 |
| 1/4" NPS(F) x 3/8" NPT(M) | 490-032 |
| 3/8" NPS(F) x 3/8" NPT(M) | 490-043 |
| 1/2" NPS(F) x 1/2" NPT(M) | 200-555 |
| 3/4" NPS(F) x 3/4" NPT(M) | 138-037 |
| 1" NPS(F) x 1" NPT(M) | 200-556 |

Maximum Working Pressure: 5000 PSI (34.5 MPa)



Pipe Plugs

| DESCRIPTION | PART NO. |
|-------------|----------|
| 1/4" NPT(M) | 227-027 |
| 3/8" NPT(M) | 227-033 |
| 1/2" NPT(M) | 210-023 |
| 3/4" NPT(M) | 210-038 |

Maximum Working Pressure: 5000 PSI (34.5 MPa)



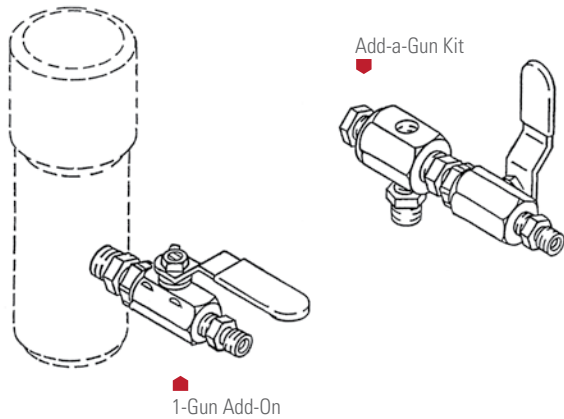

Gun Add-On Kits:

Can be used on pumps with an open 3/8" NPT port on the manifold.

| INCLUDES | 1-GUN ADD-ON | | ADD-A-GUN | |
|-----------------|----------------------|----------------------|----------------------|----------------------|
| | 975-111 1/4" Hose | 975-311 3/8" Hose | 975-200 1/4" Hose | 975-300 3/8" Hose |
| Nipple, Hex | 814-002 | 814-004 | 814-002 | 814-004 |
| Ball Valve | 940-553 | 941-555 | 940-553 | 941-555 |
| Nipple, Hex | 227-006 | 808-555 | 227-006 | 808-555 |
| Plug, Pipe | | | 227-033 | 227-033 |
| Block, Manifold | | | 970-100 | 970-100 |
| Nipple, Hex | | | 814-004 | 814-004 |

Maximum Working Pressure: 3600 PSI (24.8 MPa)

Multiple Gun Add-on Assemblies (1/4")

Hose connection 1/4" MPSP (M).

| INCLUDES | 975-212 | 975-213 |
|-------------------------|---------|---------|
| | 2-Guns | 3-Guns |
| 1-Gun Add-On (975-111) | 1 | 1 |
| Add-A-Gun Kit (975-200) | 1 | 2 |

Maximum Working Pressure: 3600 PSI (24.8 MPa)

Multiple Gun Add-on Assemblies (3/8")

Hose connection 3/8" NPSM (M).

| INCLUDES | 975-312 | 975-313 | 975-314 |
|-------------------------|---------|---------|---------|
| | 2-Guns | 3-Guns | 4-Guns |
| 1-Gun Add-On (975-311) | 1 | 1 | 1 |
| Add-A-Gun Kit (975-300) | 1 | 2 | 3 |

Maximum Working Pressure: 3600 PSI (24.8 MPa)

High Pressure Ball Valve

| FITTING SIZE | PSI | PART NO. |
|--------------|-----------------|----------|
| 1/4" | 6000 (41.4 MPa) | 0533358 |
| 1/4" | 7500 (51.7 MPa) | 0533348 |
| 3/8" | 6000 (41.4 MPa) | 0533359 |
| 3/8" | 7500 (51.7 MPa) | 0533347 |

FULL FLUID SECTION ASSEMBLIES KEEP YOU ON THE JOB.

Impact, PowrTex & MultiFinish

| DESCRIPTION | PART NO. |
|---------------------------------------|----------|
| Impact® 340/400 Skid | 0532921A |
| Impact 400 High Rider | 0532922A |
| Impact 440, 540, 640 (Skid/Low Rider) | 805-207A |
| Impact 440, 540, 640 (High Rider) | 805-233A |
| Impact 740, 840 (All Models) | 805-236A |
| Impact 1040 | 0552603A |
| Impact 1140 (High Rider) | 805-246A |
| PowrTex 1200 SF | 800-710 |
| Multifinish™ 440 | 805-207A |

Elite Series

| DESCRIPTION | PART NO. |
|-------------|----------|
| Elite™ 3500 | 0537903 |

PowrBeast Series

| DESCRIPTION | PART NO. |
|----------------------|----------|
| PowrBeast 4700 | 0537255 |
| PowrBeast 4700T | 0537268 |
| PowrBeast 7700, 9700 | 0537256 |

PowrTwin & Hydra Series

| DESCRIPTION | PART NO. |
|---|----------|
| PowrTwin™ 4900 Plus (All Models) | 107-005 |
| PowrTwin 6900 Plus (All Models) | 236-005 |
| PowrTwin 6900 Plus DI (All Models) | 451-210 |
| PowrTwin 8900 Plus, 12000 Plus (All Models) | 236-015 |
| PowrTwin 12000 Plus DI (All Models) | 236-024 |
| Hydra™ Pro IV | 185-551A |

PowrLiner Series

| DESCRIPTION | PART NO. |
|----------------------------------|----------|
| PowrLiner™ 2850 | 0290513A |
| PowrLiner 4950/4955 (All Models) | 107-005 |
| PowrLiner 6950/6955 (All Models) | 236-005 |
| PowrLiner 8950/8955 (All Models) | 236-015 |

AirCoat & PowrCoat Series

| DESCRIPTION | PART NO. |
|--------------------|----------|
| AirCoat™ 423 | 0533243 |
| AirCoat 620 | 0533244 |
| PowrCoat™ 730, 940 | 185-551A |
| PowrCoat 745, 960 | 155-559A |
| PowrCoat 975 | 0533908 |
| PowrCoat 1045 | 0533262 |
| PowrCoat 1064 | 0533263 |
| PowrCoat 1072 | 0533264 |

HARD WORKING LINE STRIPER ACCESSORIES



TR² Line Striping Tips

From striping to stenciling – with the twist of the tip.

| STRIPING TIP SIZE | STENCIL TIP SIZE | FLAG | FILTER COLOR | PART NO. |
|-------------------|------------------|--------|--------------|-------------|
| 417 | 517 | Yellow | White | 694-1708517 |
| 419 | 519 | Yellow | White | 694-1908519 |
| 421 | 621 | Yellow | White | 694-2108621 |
| 423 | 623 | Yellow | White | 694-2308623 |

WindGuard™ Spray Shield 0290623

Spray shield protects spray pattern from wind, minimizing over-spray. Works well when applying diluted athletic field marking paints. Adjustable for easy “on the fly” line width changes – 4", 6" or 8" and is easily removed from sprayer.

- Attaches to any Titan PowrLiner and most competitive models
- Spring-loaded shields promote forgiveness on uneven surfaces
- Lightweight – only 5.5 lbs.



WindGuard™ Spray Shield



Stencil Kit

Stencil Kits

Molded of 1/8" (.15 cm) polyethylene, these stencils are very durable and lay flat on surfaces for clean and accurate marking.

| STENCIL KIT 1 | INCLUDES | PART NO. |
|----------------------|----------|----------|
| 39" (99 cm) Handicap | | 0290932 |

| STENCIL KIT 2 | INCLUDES | PART NO. |
|-------------------------|----------|----------|
| 39" (99 cm) Handicap | | 0290933 |
| 12" (30 cm) No Parking | | |
| 12" (30 cm) Numbers 0–9 | | |

| STENCIL KIT 3 | INCLUDES | PART NO. |
|---|----------|----------|
| 42" (105 cm) Straight and Curved Arrows | | 0290934 |
| 39" (99 cm) Handicap | | |
| 12" (30 cm) Numbers 0–9 | | |
| 4", 12" (10, 30 cm) No Parking | | |
| 4", 12" (10, 30 cm) Fire Lane | | |
| 4" (10 cm) Reserved | | |
| 4" (10 cm) Visitors | | |

LineSite™ Laser Pointer 0290175A

Great for starts/stops, curb striping, executing perfectly straight lines and training new employees. High-intensity green laser is easy to see in daylight.

HandiBead™ Bead Dispenser 0290953A

Apply glass beads with consistency and accuracy. Eliminates hand tossing glass beads on stop bar or crosswalk applications.

- Adjustable diffuser can disperse material up to 15" wide



HandiBead Bead Dispenser

Aluminum Die

Order in standard widths ranging from 4–12" or call for custom sizes.

- Available in adjustable mil
- Double drop compatible



Aluminum Die

Double Die

Allows you to lay both center lines in a single pass, increasing productivity and putting more money in your pocket.

- Double drop compatible



Double Die

| DESCRIPTION | PART NO. |
|--------------------------------------|------------------|
| Double Die, 4" x 4" x 4", 90 mil | ASE17100000A.090 |
| Double Die, 4" x 4" x 4", 125 mil | ASE17100000A.125 |
| Double Die, 4" x 4" x 4", Adjustable | ASE17100000A.ADJ |
| Double Die, 4" x 3" x 4", 90 mil | ASE17200000A.090 |
| Double Die, 4" x 3" x 4", 125 mil | ASE17200000A.125 |
| Double Die, 4" x 3" x 4", Adjustable | ASE17200000A.ADJ |
| Double Die, 4" x 6" x 4", 90 mil | ASE17300000A.090 |
| Double Die, 4" x 6" x 4", 125 mil | ASE17300000A.125 |
| Double Die, 4" x 6" x 4", Adjustable | ASE17300000A.ADJ |



Glass Bead Dispensing Systems

Includes hopper, hose and dispenser.

| DESCRIPTION | PART NO. |
|--|----------|
| 1-Gun Kit (4-6") | 424-826 |
| 2-Gun Kit (4-6") | 424-836 |
| 1-Gun Kit (12") | 424-840 |
| 2-Gun Kit (12") | 424-841 |
| Add a Second Dispenser to your One-Gun Kit Second Dispenser with Hose (4-6") | 424-816 |

Compatible with: 4950, 4955, 6950, 6955, 8950, 8955, 4900XLT, 6900XLT and 8900XLT.
LazyLiner™ and PowrLiner™ sold separately.



SureTrak™ Floating Gun Kit



LazyLiner™ Tray

SureTrak™ Floating Gun Kit 759-120

Keeps the gun at the proper height from the surface for perfect lines over rough terrain.

- ▀ Works great on pavement, grass and turf
- ▀ Attaches to PowrLiner™ 4950, 4955, 6950, 6955, 8950 and 8955

LazyLiner Tray

Use this attachable tray system as an option for carrying around additional items.

- ▀ For use on the LazyLiner Pro and Elite

| DESCRIPTION | PART NO. |
|---|----------|
| LazyLiner Pro Tray (Must add bumper 0290646Z) | 0290646Z |
| LazyLiner Elite Tray | 0290645Z |

Second Gun Kit

Comes complete with mounting bracket, airless gun, ¼" x 6' hose and line striping tip. Mounts to 4950, 6950 and 8950 PowrLiner.

| DESCRIPTION | PART NO. |
|------------------------|----------|
| S-3 Gun Kit | 759-138 |
| PowrLiner 2850 Gun Kit | 0290310 |

SmartArm™ Assembly 0290382

Built to make line adjustments and transportation quick and easy.

- ▀ Pivots down for spraying and up for transportation/storage
- ▀ Locks at any angle for curb striping
- ▀ Adjust gun height (fan pattern) up/down with the turn of a lever
- ▀ Automatically centers spray arm for easy set-up
- ▀ Graduated to return to your preferred spray position

Striper Add-On Accessories

| RECOMMENDED GUNS | |
|------------------|----------|
| DESCRIPTION | PART NO. |
| LX-40 Gun | 550-540 |
| RX-80 Gun | 0538015 |
| S-3 Gun | 0550060 |

| UPGRADES | |
|-----------------------------------|----------|
| DESCRIPTION | PART NO. |
| PowrLiner™ 850 Caster Release Kit | 0293970 |
| 12-Gallon Hopper | 759-130 |
| Polyethylene 5-Gallon Pail Cover | 759-147 |
| Turf Kit for PowrLiners 4955-8955 | 759-155 |

Hitches and Bumpers

| DESCRIPTION | PRO | ELITE |
|---|----------|----------|
| | PART NO. | PART NO. |
| PowrLiner 2850 | 0290043Z | 0290043Z |
| PowrLiner 3500 Hitch Kit and Bracket | 0537935 | 0537935 |
| PowrLiner 3500 Hitch Bracket | 0290182 | 0290182 |
| PowrLiner 4950, 4900xlt, 6900xlt, 8900xlt | 0290180 | 0290180 |
| PowrLiner 6950, 8950 | 0290180 | 0290180 |
| PowrLiner 4955, 6955, 8955 | 0290180 | 0290180 |
| Graco® 3900 and Up | 0290050Z | 0290050Z |
| Bumper / Engine Protection Bar | 0290646Z | Included |

The drivers are not shipped with a hitch; use chart to identify which hitch to order.

TOOLS FOR THE PERFECT FINISH



Maxum Elite Gun



Maxum II Gun



Maxum Elite Gun with Gravity Cup and Stand

Maxum Elite Gun

For contractors and finishing professionals who expect flawless results with the versatility to use gravity- or siphon-fed cup gun.

- Removable and reversible fluid chamber design enables use with standard pressurized cup and pressurized gravity cup
- Stainless steel fluid passages
- Fluid needle stays with packing and head assembly for color and tip size changes—allows for easier storage and clean up
- Integrated check valve in gun head
- Patented grip design for stay-cool operation
- Multi-position pick-up tube for spraying at various angles
- Comes standard with a #3 Proset (Needle set)

| DESCRIPTION | PART NO. |
|----------------------------------|----------|
| Maxum Elite Gun with 1 Qt. Cup | 0524027 |
| Maxum Elite Gun with Gravity Cup | 0524052 |

MAXUM ELITE ACCESSORIES

| DESCRIPTION | PART NO. |
|---|----------|
| Pressure-Fed 1 Qt. Cup | 0524027 |
| Front End Accessory with 1 Qt. Cup Assembly and #3 Proset | 0524073 |
| Front End Accessory with 1 Qt. Cup Assembly and #4 Proset | 0524074 |
| Gravity Cup Accessory with Stand | 0524045 |

Maxum II Gun

For maximum control and pinpoint-accurate coating delivery, the Maxum II is an excellent choice for contractors and finishing professionals who need a precise fine finishing tool.

- Ability to convert from non-bleeder to bleeder gun
- Comes standard with a #3 Proset (Needle set) and 1 Qt. cup

| DESCRIPTION | PART NO. |
|--|----------|
| Maxum II Gun with Pressure-Fed 1 Qt. Cup | 0524041 |

Projector Sets

| DESCRIPTION | MAXUM II PART NO. | MAXUM ELITE PART NO. |
|----------------------------|-------------------|----------------------|
| #2 Proset (Fine Finish) | 0276254 | 0524293 |
| #3 Proset (All-Purpose) | 0276227 | 0524294 |
| #4 Proset (High Output) | 0276228 | 0524295 |
| #5 Proset (High Output) | 0276229 | 0524296 |
| #6 Proset (High Output) | 0276245 | 0524297 |
| #7 Proset (Highest Output) | 0524211 | 0524298 |

Maxum II 
Standard Kit



Maintenance and Repair Kits

| MAINTENANCE KITS | | |
|------------------|----------------------|-------------------------|
| DESCRIPTION | MAXUM II PART NO. | MAXUM ELITE PART NO. |
| Deluxe Kit | 0279941 | 0524189 |
| Standard Kit | 0279942 | 0524188 |

Gun Repair Kit 
for Maxum II Gun



| GUN REPAIR KITS / PARTS | |
|---|----------|
| DESCRIPTION | PART NO. |
| Replacement Check Valve Assemblies (three-pack) | 0297051 |
| Check Valve Seals (10-Pack) | 0276257 |
| Gun Repair Kit for Maxum II Gun | 0277943 |
| Gun Repair Kit for Maxum Elite Gun | 0524187 |
| Spring Plate Assembly | 0275250 |
| Gun Repair Kit for 3100 Gun (Siphon and Pressure-Fed) | 0550985 |
| Gun Repair Kit for 3100 Gun (Gravity Fed) | 0552916 |



REPLACEMENT TURBINE FILTERS

| DESCRIPTION | PART NO. |
|--|----------|
| Air Filter Kit (Pleated) Capspray™ 95, 105 and 115 Atomizing Air | 0524523A |
| Air Filter Kit (Foam-Black) Capspray 75 Motor Cooling | 0529390 |
| Air Filter Kit (Foam-Green) Capspray 75 Atomizing Air | 0529390 |
| Pre-Filter Kit (Qty. 2) Capspray 55, 75, 95, 105 and 115 | 0524526A |

Accessories

CUPS AND ACCESSORIES

| DESCRIPTION | PART NO. |
|---|----------|
| 1-Qt. Cup Assembly with Swivel Tube | 0277183 |
| 1-Qt. Replacement Cup | 0275573 |
| 2-Qt. Remote Cup System (Complete) | 0524203 |
| Air-Tight Lid for Paint Cups (Keeps paint fresh for long periods) | 0508124 |
| Cup Assembly without Swivel Tube | 0275247 |
| 600 ml HVLP Top Feed | 0524211 |
| Gravity Cup Assembly with Stand | 0524045 |
| White, 1 Qt. Cup Gaskets, Hot Solvents (6-pack) | 0297052 |
| White, 2 Qt. Cup Gaskets, Hot Solvents | 0524337 |

White, 1 Qt. 
Cup Gaskets





Air Hoses and Fittings

| DESCRIPTION | PART NO. |
|------------------------------|----------|
| 20' x 3/4" Flex Air Hose | 0275276 |
| 25' x 3/4" Flex Air Hose | 0275277 |
| 30' x 3/4" Flex Air Hose | 0277337 |
| 30' Air Hose | 0295689 |
| 5' x 3/4" Air Whip Hose | 0524405A |
| 30' x 3/8" Material Hose | 0277348 |
| Quick Disconnect (F) Turbine | 0275625 |



HVLP Power Cart

A compact, lightweight solution to major application projects.

| HVLP POWER CART & ACCESSORIES | |
|-------------------------------|----------|
| DESCRIPTION | PART NO. |
| HVLP Power Cart | 0524000 |
| Pressure Pot Liner | 0275702 |
| Pressure Pot Liner (12-Pack) | 0295272 |
| Solvent Resistant Gasket | 0508943 |

2 Qt. Remote Cup 0524203

Transform your turbine system into a high-capacity sprayer without adding the cost and weight of a bulky air compressor.

For use with Capspray 75-115 sprayers.
5' Air whip hose sold separately.



Gun sold separately.



3M® PPS™ Paint Preparation System

3M PPS Paint Preparation System is a unique, closed paint system that eliminates the need for separate mixing cups and filters. Instead, paint is mixed in a liner bag which marries to a direct filter and is then mounted on the spray gun with a dedicated adapter.

- As freshly-filtered paint is dispensed, the liner bag collapses, allowing the spray gun to function at any angle.
- Liner bag and filter are disposable, leaving only the spray gun and adapter to be cleaned.
- 3M PPS Paint Preparation System is a cleaner, faster system, safe from outside contamination and offers considerable time and solvent savings on gun and parts cleaning.

| DESCRIPTION | PART NO. |
|--|-----------|
| PPS Starter Kit (Includes Pressure Cup, Collar, Gun Adapter, 10 Plastic Cup Liners and Lids) | 2389965 |
| Pressure Cup and Collar | 91-460 |
| Gun Adapter | 91-475 |
| Plastic Cup Liner and Lids (25) | 91-462-25 |

KEEP YOUR EQUIPMENT CLEAN AND WORKING FOR YOU

No matter what the sprayer – hydraulic, gear-driven, gas-powered or electric – if you want a long service life you will need to care for it with the same attention you care for your own car or truck. That means changing the oil, lubricating the piston, cleaning the unit, the gun and the tip. Titan has all the products you need to keep your accessories and equipment clean and functioning in top condition.

PumpRunner™ 0286008

PumpRunner prevents the inlet valve from drying out, ensures clean transport and reduces clean up time. Works on most high rider model sprayers.

Sprayer sold separately.



LS-10 Liquid Shield Plus™

Cleans and protects your spray system against rust and corrosion, extending the life of your pump.

- Includes anti-freeze protection

| DESCRIPTION | PART NO. |
|-----------------|----------|
| 4 oz. Bottle | 314-483 |
| 1 Qt. Bottle | 314-482 |
| 1 Gallon Bottle | 0521418 |

Pump Shield™ 0297055

Cover your sprayer to prevent paint overspray from sticking to it. Keeps your sprayer looking like new.



Tip Clean™ 314-207

Hour-glass design allows easy cleaning of all airless tips and safe storage. Cleaning fluid removes contamination and paint residue, ensuring best spraying results. **7 oz. (200 ml) Bottle**



Piston Lube™

Specially formulated to prevent materials from adhering to the piston rod. Suitable for use with most airless piston pumps.

| DESCRIPTION | PART NO. |
|--------------|----------|
| 4 oz. Bottle | 314-481 |
| 8 oz. Bottle | 314-480 |
| 1 Qt. Bottle | 700-926 |

Paint Mate™

Water-based coating additive that significantly improves atomization with HVLP sprayers without compromising the integrity of the coating.



| DESCRIPTION | PART NO. |
|--------------------------|----------|
| 1 Qt. Bottle | 0508071 |
| 1 Qt. Bottle (Case of 6) | 0508069 |

Air Care™ 311-101

Pneumatic equipment lubricant storage protector. Contains premium additives to extend life of equipment. **1 Qt. Bottle**



Coolflo™

Hydraulic Fluid for PowrTwin™, Hydra™ and sealed hydraulic sprayers.

| DESCRIPTION | PART NO. |
|---------------------------|----------|
| 1 Qt. Bottle | 430-362 |
| 1 Qt. Bottle (Case of 12) | 430-363 |

Lubriplate™/GR-132

Specially designed for gear boxes.



| DESCRIPTION | PART NO. |
|-------------|----------|
| 14 oz. Can | 314-171 |
| 6 lb. Can | 9870307 |

Part Renu™

Safely remove paint from spray guns and sprayer accessories. This non-flammable, water-based cleaner is environmentally safe, odor free and will not burn skin. Easily washes off with water.



- Starter Kit includes easy-to-use strainer

| DESCRIPTION | PART NO. |
|----------------------|----------|
| 1 Gallon Part Renu™ | 0521423 |
| 5 Gallon Starter Kit | 0521010 |

WEAR GUARD

CONVENIENCE PROGRAM



PLATINUM PROGRAM

GET A SPARE FLUID SECTION
and save up to 80%
when you purchase a qualifying sprayer below:

LEVEL 1 **Impact® 400** **\$125⁰⁰**
CAD \$163

LEVEL 5 **PowrBeast™ 4700, 4700T, 7700, 9700**
Impact 1640 **\$368⁰⁰**
CAD \$482

LEVEL 2 **Impact 440*, 540*, 640***
MultiFinish® 440
PowrLiner® 2850 **\$246⁰⁰**
CAD \$322

LEVEL 6 **AirCoat® 423, 620**
PowrCoat™ 630 **\$399⁰⁰**
CAD \$522

LEVEL 3 **Impact 740, 840, 1040, 1140** **\$269⁰⁰**
CAD \$352

LEVEL 7 **PowrCoat™ 730, 745, 940, 960, 975, 1045, 1064, 1072**
Hydra™ Pro IV **\$618⁰⁰**
CAD \$809

LEVEL 4 **PowrTwin® 4900, 6900, 8900, 12000 Plus**
PowrLiner 4955, 6955, 8955 **\$335⁰⁰**
CAD \$439

*IMPACT® 440, 540 640 FLUID SECTIONS
INCLUDE \$375 IN ADDED FEATURES
MANIFOLD FILTER HOUSING | PRESSURE TRANSDUCER | SUREFLO™ PUSHER VALVE | PRIME SPRAY VALVE

ELITE PROGRAM

GET A PERMASTROKE KIT
and save up to 55%
when you purchase a qualifying sprayer below:



LEVEL 1 **AirCoat** **\$80⁰⁰**
CAD \$105

LEVEL 2 **Elite™ 3500;**
PowrLiner 3500 **\$110⁰⁰**
CAD \$144

*Tax not included. Prices subject to change.



CONNECTOR APP
Available for download
theconnectorapp.com

Call Technical Services at
1-800-526-5362
for complete warranty information.

All information contained in this brochure is based on the latest information available at the time of printing. Titan reserves the right to make changes at any time, without notice. Due to continuous innovation, specifications may progressively change. Contact one of our dependable sales reps or call our dedicated customer service team for more information.